



CUBBY HOUSES BY **SteelChief**

*Let's have fun*

[littlechiefplay.com.au](http://littlechiefplay.com.au)





CUBBY HOUSES BY **SteelChief**



SteelChief is one of Australia's leading manufacturers of high-quality outdoor living products. All of SteelChief's products are supplied as pre-assembled roof and wall panels which ensures they are the most straight-forward DIY solution on the market. It's as easy as screwing the panels together! SteelChief is a family-owned Australian business. We draw on more than 36 years of experience, and our products are designed and built to the highest standards.





CUBBY HOUSES BY **SteelChief**

LittleChief is the younger sibling of SteelChief, a family-owned Australian business that specialises in high-quality outdoor living products.

Born out of a desire to encourage kids to play outside, our cubbies are designed to inspire creativity, exploration and group play. Whether it's a bustling café, a magical castle or an exciting fire station, our cubbies become the starting blocks for all kinds of stories and adventures.

Built to the highest standards, our aim is to provide you with the widest range of cubbies, forts and play equipment, which can be customised to meet your specific needs and requirements.

*Let's have fun*





# Boutique Cubby Range

LittleChief's new Boutique range is designed for the smaller backyard and is made from plantation pine. You can leave it raw to weather naturally over time or paint it any colour combination of your choice. The sky is the limit!

*Let's have fun*



## The Castle

With its open design and extended roof height, The Castle encourages the whole family to play. The addition of a Tower allows you to add any accessory (slide, climbing wall etc.), while The Castle's decked floor will withstand any weather.

## The Nursery

This cubby is designed with nurseries, day-care centres and kindergartens in mind. Its open design allows carers to have a clear view of the children at play, while its decked floor will withstand all weather conditions.

## The Cafe

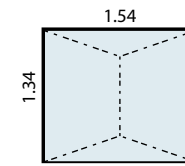

**\$1419**  
Cubby staining \$169

## The Garage

**\$1659**  
Cubby staining \$205

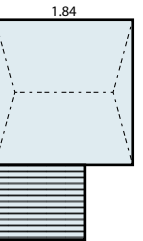

The Garage cubby comes with a lockable double door, a ramp and two windows. Like all our designs, The Garage is versatile and can be attached to the base of The Tower. Add a servery window, an alfresco extension, or any accessory of your choice! **As Standard:** Front includes a double door, a window and a ramp. Second window in the side. Height 2.0m. Pictured product has been painted which is not included in price.

With its long servery window and awning, this cubby can be transformed into a café, shop or market stall. Add large and small planter boxes, signage and more! **As Standard:** Door in front and window in back. A servery including shelf, awning and 2 painted doors in gable end. Height 1.95m. Pictured product has been painted which is not included in price.

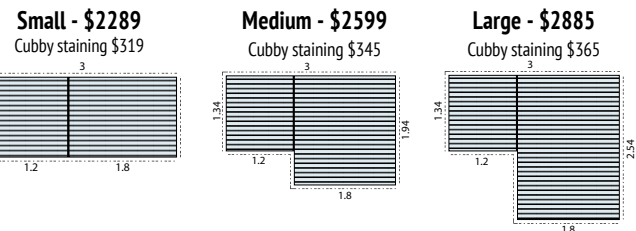

**Small - \$2289** Cubby staining \$319  
**Medium - \$2599** Cubby staining \$345  
**Large - \$2885** Cubby staining \$365

**As standard:** Includes 1 access opening in each wall. Elevated floor height 1.2m. Roof height 2.85m. Customer to nominate Tower position - forward or back. **As pictured:** Large Castle with optional\* 1.2m scramble net, middle balustrade, and 2.5m slide.

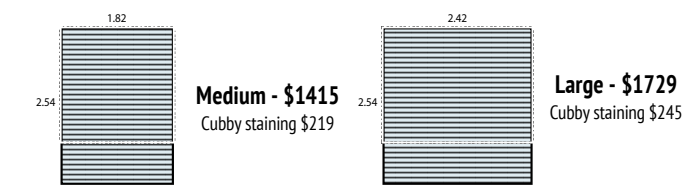

**Medium - \$1415** Cubby staining \$219  
**Large - \$1729** Cubby staining \$245

**As Standard:** Includes open front and side access opening. Height 1.8m front / 1.63m rear. Customer to nominate access side - left or right. Cladding butt finished on the inside of the back and side wall - natural timber shrinkage will create gaps in external cladding. **Medium Nursery pictured.**



The Crate is our new eco-friendly cubby. Made from recycled and new materials, The Crate's timber is untreated. You can leave it raw to weather over time or paint it any colour to suit your backyard scheme. **As standard (above):** Single door in front wall and window in back wall. Height 1.68m front / 1.59m rear. **As pictured (right):** XLarge Crate with optional\* 1.8m and 2.4m stained deck extensions, stencil signage and servery. Product external walls are painted.

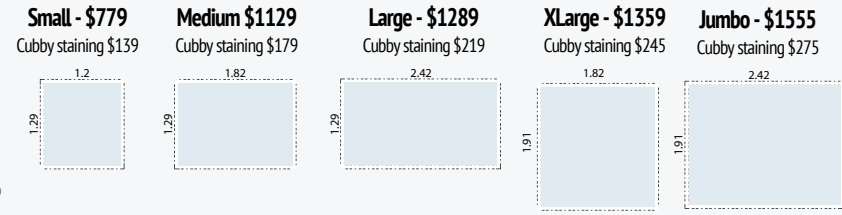

**Small - \$779** Cubby staining \$139  
**Medium \$1129** Cubby staining \$179  
**Large - \$1289** Cubby staining \$219  
**XLarge - \$1359** Cubby staining \$245  
**Jumbo - \$1555** Cubby staining \$275

## The Crate

**0.6m Deck Extension**  
front and/or side (Customer to nominate).  
1.2m W \$95, 1.8m W \$119, 2.4m W \$149  
\*staining \$39

**Servery \$265 + staining \$49**  
Opening with a shelf, awning and 2 painted doors.

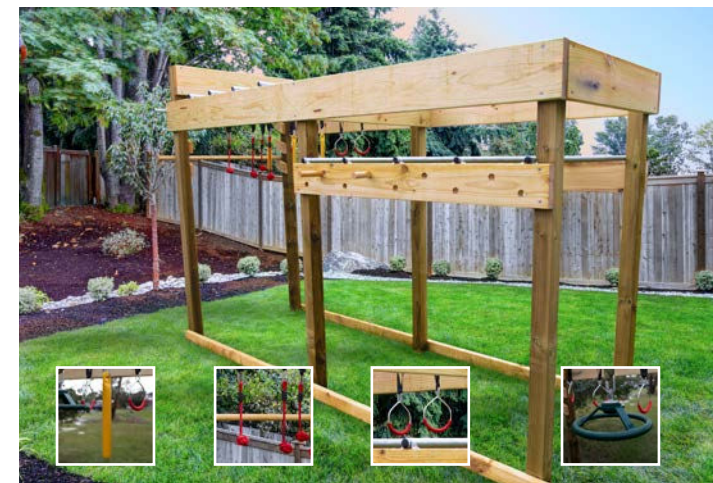

**Ninja steel pipes \$59** **Ninja knots \$49** **Ninja rings \$45** **Ninja steering Wheel \$115**

## The Ninja

**\$2139**  
Staining \$235

The Ninja is a versatile obstacle course that is designed to challenge the whole family. With it's monkey bars, monkey grips, trapeze bar, rings and ropes. The Ninja focuses on balance, strength, coordination and agility. The Ninja allows obstacles to be moved further apart depending on size and skill level. Easy to install, the Ninja can be custom designed to suit any garden space, exercise regime, or other requirements. **As Pictured:** End posts 2.4m high, Frame height 2.1m. Length 3.6m. Width 1.29m. Standard includes bars, peg board and fish ladder. Swing attachments are optional extras.



## The Station

**\$2845**  
Cubby staining \$415

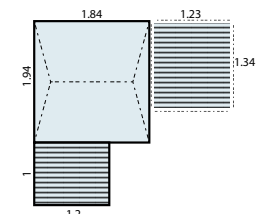

The Station cubby will inspire the most creative adventures. Combining the Garage model with a Tower, you can add any cubby accessory of your choice! Paint it white and red to create a real fire station - and as with all our designs, you can add a sign with your child's name for their own personalised cubby! **As Pictured:** Front includes double door, window and a ramp. Window in one gable side, access door to Tower in the other includes a ladder. Access openings in each wall of the Tower. Elevation floor height 1.2m. Roof height Station 2.0m, Tower 2.82m. Optional\* 2.5m slide and painting.



# Cubby House Options

## Elevation Kits



	BEACH SHACK	THE HUT & HIDEOUT	SMALL FORT	LARGE FORT
<b>ABOVE GROUND</b>				
1.2m ELEVATION KIT		\$669	\$539	\$679
1.5m ELEVATION KIT		\$739	\$569	\$749
STAINING OF ELEVATION		\$219	\$199	\$219
<b>INGROUND</b>				
0.45m ELEVATION KIT	\$295	\$355	\$275	\$365
1.2m ELEVATION KIT	\$559	\$429	\$559	\$559
1.5m ELEVATION KIT	\$645	\$509	\$645	\$645
STAINING OF ELEVATION	\$125	\$135	\$109	\$135

Inground Elevations: Posts are 0.6m longer so they can be dug into the ground and concreted in place. Posts can be trimmed to height to suit uneven ground. Above Ground Elevations: Includes sandpit boards which form bracing support for posts. No need to dig posts into ground.

## Roof Colours

At LittleChief we let you be as creative with colour as you like. Select any of our 13 colours for your roof or Zinc.

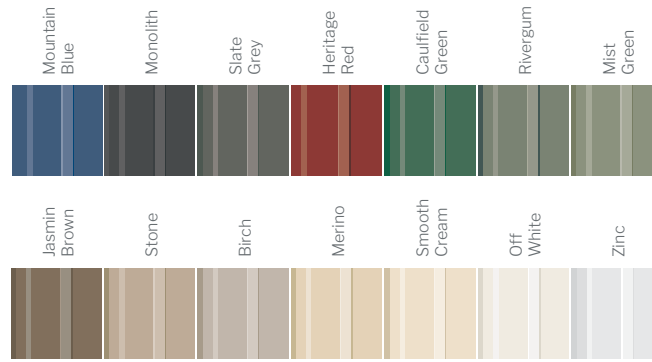

## Timber Finish

Protect your cubby from the elements with our staining service. Panels are fully immersed in our stain tank to ensure the best possible interior and exterior protection. (We suggest there is no need for staining of particle board floor.) See Cubby details for pricing.

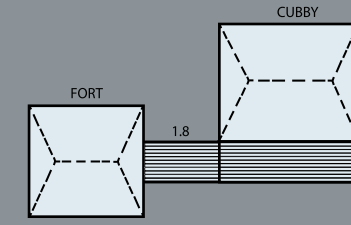
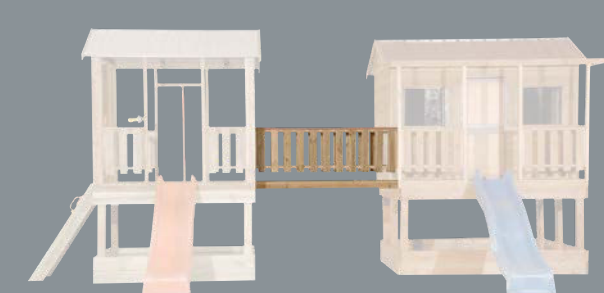

**Bridge**  
\$515  
Bridge staining \$75

Use the connecting bridge to join forts or cubbies to create your own adventure playground.

**Alfresco**  
Medium \$825 Staining \$135  
Large \$999 Staining \$155

This addition comes in two sizes to suit a wide range of backyard spaces. The Alfresco can be added to any of the cubbies in our range. A protected area on the side can be used as a carport or an alfresco play space. Great for rainy days! As Standard: Attaches to side of existing cubby house. Select size to suit cubby depth. Open front with access ramp. Single opening in side.

**Sandpit**  
As Standard: The Sandpit attaches to the side of your cubby house. Select size to suit depth of Cubby. Single row of sandpit boards with roof and supports.

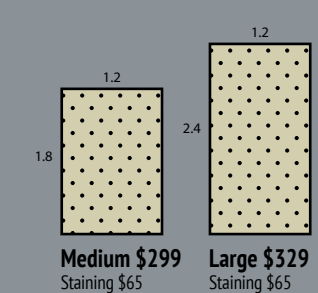

Medium \$299 Staining \$65  
Large \$329 Staining \$65

General: Playgrounds should be installed on flat stable ground. Allow 2 metres space from solid structures to ensure safe use. 3.5m clearance required in front and behind swings. Cubby verandah or Fort openings need to be filled with options or balustrades if elevated. Suitable under surfacing is required as per Australian Standard AS 4685:2014 recommendations. Adult supervision and guidance is required for children using these products.

## Extra Fun!

AVAILABLE COLOUR RANGE: ● ● ● ● ●

**\$39** FLOWER BOX

**\$55** LETTER BOX  
+\$9 STAINED

**\$55** SKYLIGHT

**\$75** BARN DOORS

**\$65** EXTRA WINDOW

**\$75** BALUSTRADES  
+\$19 STAINED

**\$19** A PAIR HAND GRIP

**\$45** PERISCOPE

**\$39** TELESCOPE

**\$259** FIREMAN'S POLE

**\$39** STEERING WHEEL

**\$55** SHIP STEERING WHEEL

**\$55** EACH D HANDLE

**\$269** 10 ROCK CLIMBING WALL  
1.2m WALL +\$65 STAINED  
**\$299** 1.5m WALL +\$69 STAINED

**\$45** SANDPIT SEAT

**\$355** 2.5M SLIDE TO SUIT 1.2m ELEVATION  
**\$409** 3.1M SLIDE TO SUIT 1.5m ELEVATION

**\$179** TO SUIT 1.2m ELEVATION +\$45 STAINED  
**\$199** TO SUIT 1.5m ELEVATION +\$45 STAINED

**\$99** TO SUIT ABOVE GROUND ELEVATION +\$55 STAINED  
**\$135** TO SUIT IN GROUND ELEVATION +\$55 STAINED

**\$35** Small Planter Box  
450L x 175W x 150H mm

**\$89** Large Planter Box  
1500L x 330W x 150H mm

**\$65** Small Blackboard  
600 x 600 mm

**\$95** Large Blackboard  
1200 x 600 mm

**\$125** Custom Cubby Signage  
300 x 150 mm Customer to nominate child's name

**\$729** SINGLE SWING FREE STANDING  
3.0L X 2.1H METRES

**\$805** DOUBLE SWING FREE STANDING  
1.8L X 2.1H METRES

**\$805** MONKEY BARS +\$125 STAINED  
3.0L X 0.6W X 2.1H METRES

**\$419** SERVERY +\$55 STAINED  
INTERNAL SHELF  
EXTERNAL AWNING  
100mm ELEVATED DECK  
900mm OPENING WITH 2 PAINTED DOORS

**\$89** BABY SWING

**\$99** SINGLE STRAP SWING

**\$109** TRAPEZE AND RINGS



# Classic Cubby House Range

LittleChief's Classic range of cubby houses and forts has endless possibilities. While our cubbies can be stained to further protect the treated timber and give it a darker finish, you can also paint the cubby in a range of colours to suit any backyard scheme. Built to the highest standards with solid construction, our classic cubbies will last many years and will easily dismantle and relocate as family needs change.



## The Beach Shack

The Beach Shack is the smallest cubby in our range and is designed with smaller backyards and courtyards in mind. With no verandah, this cubby can be transformed into anything. Add a café servery and turn the shack into an imaginary shop front. Continue along this theme by decorating the shack with a couple of flower boxes and let your child's imagination run wild. Although compact, the shack's multiple windows enhance a feeling of spaciousness inside. The Beach Shack is available in two sizes. Depending on your space, you can also add a sheltered sandpit.

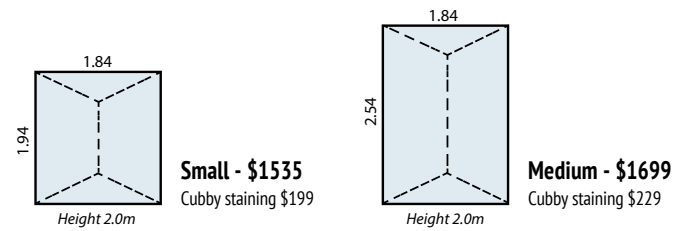

As Standard: Door and two windows in the gable, one window in the side. As Pictured: Small Beach Shack with optional\* 0.45m elevation kit.



## The Hut

The Hut is our original design and our most popular cubby style. Designed to look like a traditional house, The Hut features a gable roof and a verandah. The Hut can be styled to suit different themes – a shop, a police station, a post office, a house. Just add any of our colourful features and accessories and you can create your own magical space. To include an adventure playground element, why not consider adding an elevation, a sheltered sandpit or an alfresco, slides, scramble nets and a rock wall. The Hut is available in three sizes.

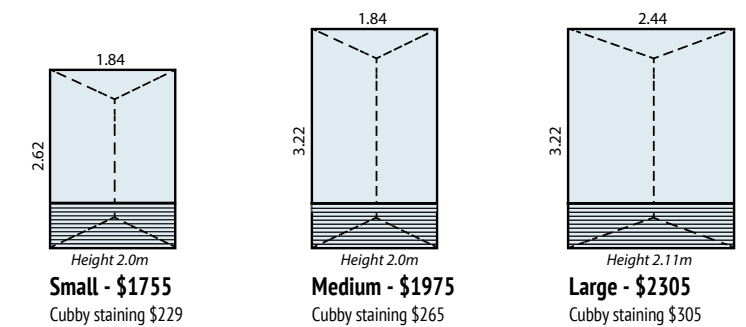

As Pictured: Small Hut with door, two windows and a verandah in the gable and one window in the side.



## The Hideout

The Hideout is a traditional cubby house with a gable roof and a flat-roof verandah. Available in three sizes, The Hideout can be adapted to suit any backyard. You can choose to install the Hideout on the ground or you can add elevation, which will open up a world of options. Once an elevation is added you can include features such as a slide, a scramble net and a rock wall. Depending on your garden space, you can also add a sheltered sandpit or an Alfresco. So many exciting choices!

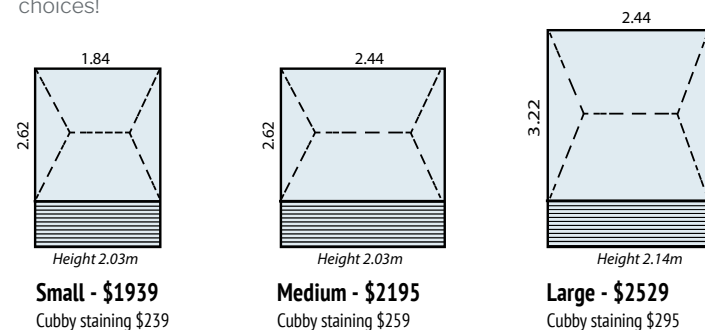

As Pictured: Large Hideout with door and two windows in the front, skillion verandah and one window in the gable side.



## All Abilities

**\$2425**  
Cubby staining \$325

With a wider doorway, no hinged door and a deeper verandah, the All Abilities cubby is designed for all little adventurers. A ramp and a wider doorway enables easy access for wheelchairs, prams, bikes and trikes. Depending on your requirements, the ramp can be fitted to the front or to the side of the cubby. Decorate this cubby with a raft of accessories including telescopes, periscopes, flower boxes and steering wheels, and turn it into a dazzling castle! As Pictured: The gable has an 850mm wide door and window opening and a 1280mm deep verandah with same width access ramp. (NB: No door or perspex fitted to these gable openings.) The access ramp can be fitted to left, right or front of verandah - please nominate position at time of order. One standard window in the side.

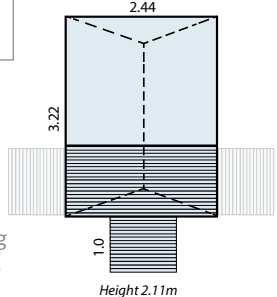

## The Fort

The Fort is a wonderful outdoor play centre the whole family can enjoy. You can choose to install the fort on the ground or add an elevation, which will open up endless adventure possibilities. Once an elevation is included you can look at adding features such as a slide, a scramble net, a rock wall, a fireman's pole, a sandpit. This playground will keep your children entertained for days. The fort is available in two different sizes. It's completely open design allows you to always see your children playing inside.

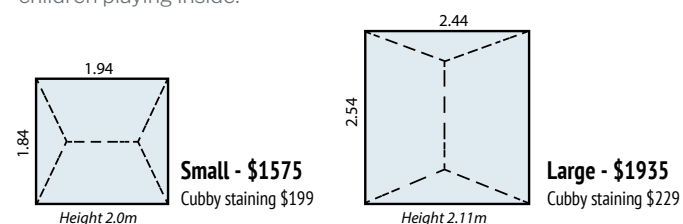

As Pictured: Large Fort with an access opening in the center of each wall.

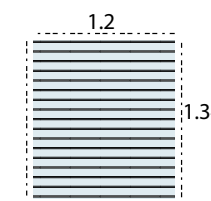

**The Tower**  
**Freestanding - \$1345 Attached - \$1185**  
Staining \$219

The Tower is an activity platform that can be freestanding or attached to the gable side of any cubby design. Accessed from an internal ladder and a secret window, The Tower can include any cubby accessory such as a slide, a fireman's pole – the list of possibilities is endless! As Pictured: Access opening in each wall. Freestanding or attaches to gable side of existing cubby house. Floor elevation height 1.2m. Roof height front 2.82m / back 2.42m.





CUBBY HOUSES BY **SteelChief**

[littlechiefplay.com.au](http://littlechiefplay.com.au) | 1300 887 852